



## 810nm 808nm Diode Ice Laser Machine 3 Wave For Skin Tightening / Pore Remover

Our Product Introduction

### Basic Information

- Place of Origin: Shandong, China
- Brand Name: KM LASER Health&Beauty
- Model Number: KM diode laser
- Price: \$3,699.00/sets 1-19 sets



### Product Specification

- Name: Diode Ice Laser Machine
- Q-Switch: NO
- Laser Type: 808nm Diode Laser
- Style: Stationary
- Type: Laser
- Feature: Skin Tightening, Pore Remover, Anti-Hair Removal, Whitening, Hair Removal, Face Lift, Acne Treatment, Skin Rejuvenation, Diode Laser For Hair Removal 808nm Beauty Machine Depilight
- Application: For Commercial
- After-sales Service Provided: Free Spare Parts, Video Technical Support, Field Installation, Commissioning And Training, Online Support, Field Maintenance And Repair Service
- Warranty: 2 Years
- Beauty Salon Equipment: 50% Discount 3D Diode Lazer For Beauty Products For Women



for more products please visit us on wfkmdz.com

### More Images

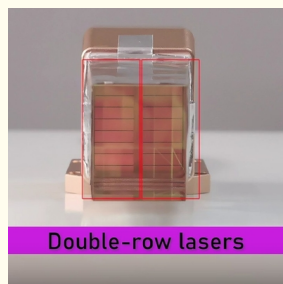

810 808nm Ice Diodo Trio 3 Wave Diode Laser The Most Effective Hair Removal Solution

### How to choose a suitable laser hair removal machine?

**We are Weifang KM electronics Co.,Ltd, a manufacturer of beauty laser machine since 2009.**

How should you choose a good supplier for the best machine, best price and timely after service?

After doing a lot of research at beauty exhibition, in the E-commerce website, or by google , all manufacturer tell you that their machine quality is best, their price is best. But for you, how do you tell the difference between the different suppliers?

To be honestly, that is not really enough time in this two minutes video for me to compare between different suppliers. But I am going to give you 4 things which you should consider

1. Don't compare a machine by it's specification parameters, it will be a misleading if you are not familiar with the machine technical. Normally, they generally think that a high power, high number on the specification means that machine is wonderful. But do you really think the machine meet your request?
2. Don't buy a very cheaper machine, don't buy a overpriced machine. Buy a machine in middle price with good value. I will tell you how choose a good price machine.
3. Don't buy machine from trading company. As we know, aesthetic beauty machines need timely and professional after service, need good training. A real manufacturer can give you technical support and online training, they can also help you to solve the machine problem with their engineer. I will tell you how to find a real manufacturer
4. Don't buy machine which don't have Medical CE, F\*A, MDL etc approval. Do you know why?



**6 different spot sizes**

**KM LASER have MDSAP AND 510 K number (we have real F\*A !!!)**



[Back To Search Results](#)

<b>Name</b>	powered laser surgical instrument
<b>ID</b>	K182924
<b>Model</b>	Diode Laser Treatment System
<b>Manufacturer</b>	Welfang KM Electronics Co., LTD No. 7999 Health East Street, High-Tech District Welfang, CN 261000
<b>Manufacturer Contact</b>	Andy Fang Welfang KM Electronics Co., LTD No. 7999 Health East Street, High-Tech District Welfang, CN 261000
<b>Product Code</b>	878_4810
<b>Registration Code</b>	GEX
<b>Registration Date</b>	10/19/2018
<b>Registration Number</b>	04/15/2019
<b>Registration Status</b>	Substantially Equivalent (SESE)
<b>Specialty</b>	General & Plastic Surgery
<b>Specialty</b>	General & Plastic Surgery
<b>Summary</b>	Traditional
<b>Primary</b>	No
<b>Secondary</b>	No

## Our Advantages

### KM LASER Machine Upgrade points

- 1)360 plus uses **6D TIP technology**.
- 2)**Six different light spots** are automatically recognized by the 6 in1 system on one handle
- 3)Automatically adjusted to the treatment parameters of the corresponding TIP,Avoid burns or lack of energy
- 4)**Double-row lasers,Energy utilization rate is over 95%**



vs!!!

**KM LASESR**

**OTHERS**

Identify

Intelligent AI recognition technology (System automatically identifies the installed spot and automatically adjusts to the treatment parameters of the corresponding TIP)

No automatic recognition

Risk

Intelligently adjust parameters to avoid burns or insufficient energy

It is easy to get burned or lack of energy when adjusting the light spot

Light loss	Passed the American Tracepro optical experimental data test, the light energy transmittance is 96.5!!	Failed the light decay test
Transmission	Wireless transmission, no problem of poor contact	Wired transmission is prone to poor contact or no data transmission
Fixed way	Magnetic force + fixing pin + curved edge teeth, no light leakage and stronger	JUST Magnetic, The light source easily diverges, Easy to deform
Chip	USA Coherent imported laser bar WITH certification	NO certification
Energy utilization rate	Energy utilization rate is over 95%	Energy utilization rate is only 60%
Certification	MDSAP ,Medical CE , TGA, TUV	NO MDSAP,TGA

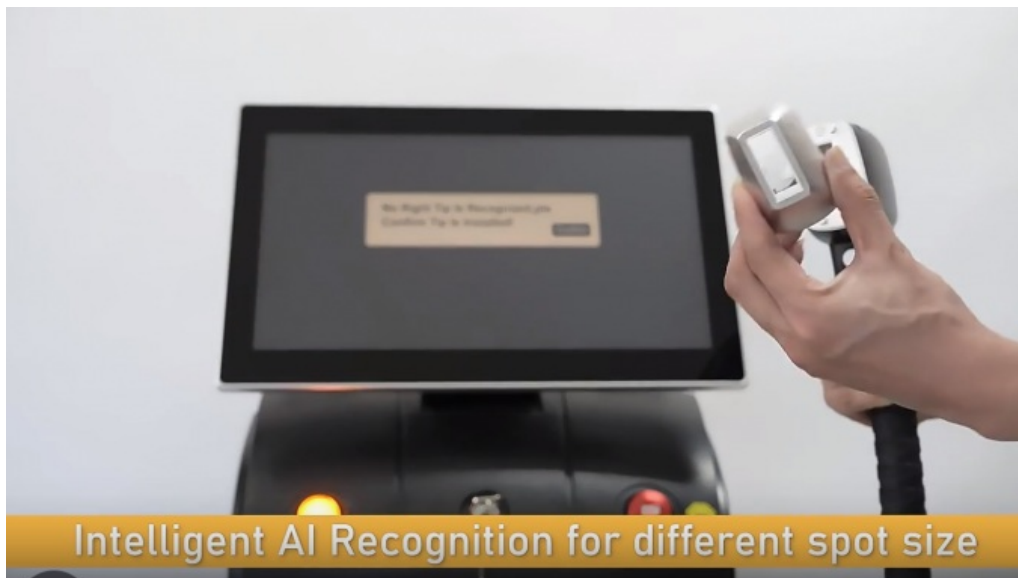

When you change the spot size, the system automatically adjusts the parameters

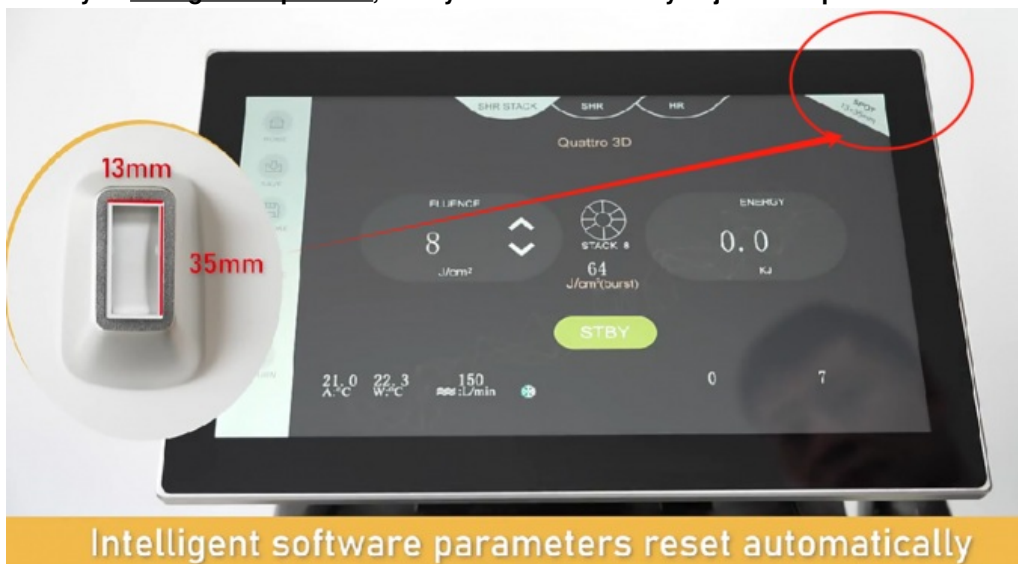

**Passed the American Tracepro optical experimental data test, the light energy transmittance is 96.5%**

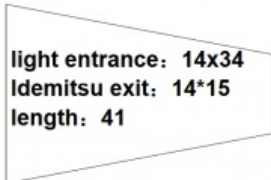
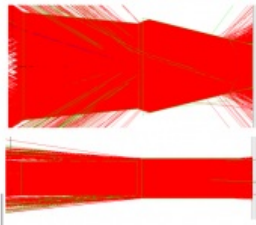
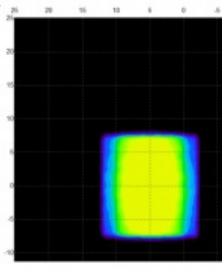
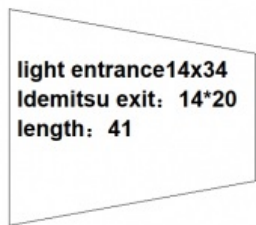
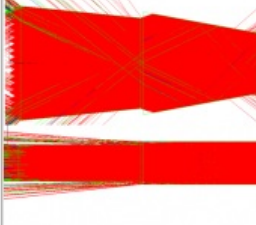
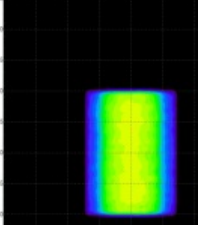
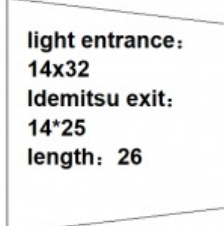
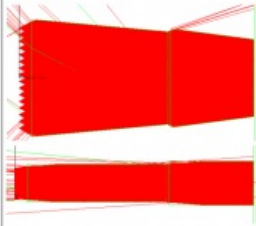
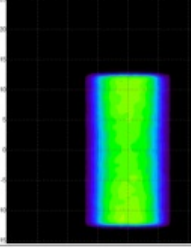
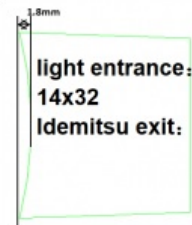
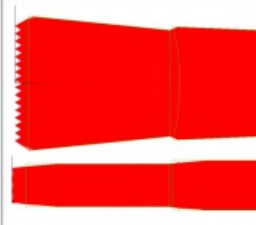
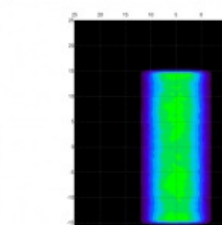
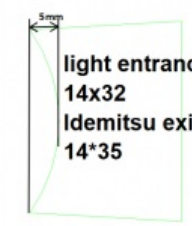
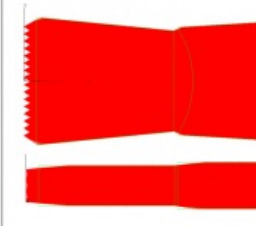
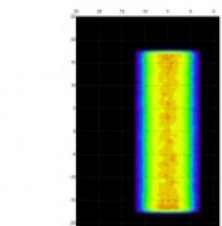
SPOT SIZE	Interchangeable head	Ray trace	Light spot diagram
14*15	 <p>light entrance: 14x34 Idemitsu exit: 14*15 length: 41</p>		
14*20	 <p>light entrance 14x34 Idemitsu exit: 14*20 length: 41</p>		
14*25	 <p>light entrance: 14x32 Idemitsu exit: 14*25 length: 26</p>		
14*30	 <p>light entrance: 14x32 Idemitsu exit:</p>		
14*35	 <p>light entrance: 14x32 Idemitsu exit: 14*35</p>		

#### Machine upgrade points

- 1)360 plus uses **6D TIP technology**.
- 2)**Six different light spots** are automatically recognized by the 6 in1 system on one handle
- 3)Automatically adjusted to the treatment parameters of the corresponding TIP,Avoid burns or lack of energy

Suitable for all parts of the body

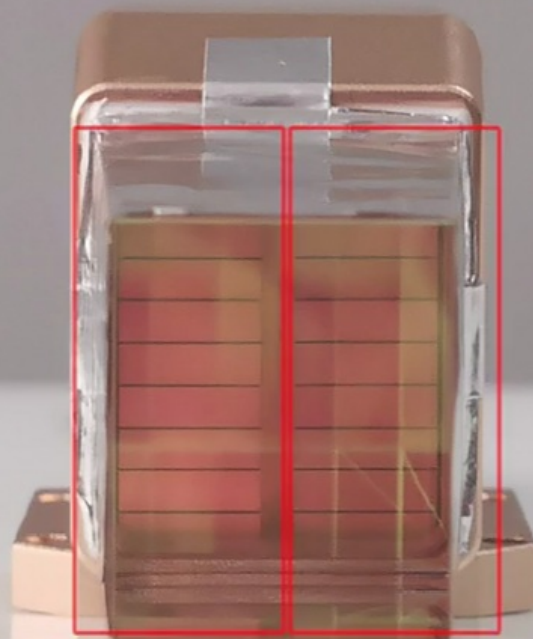

Double-row lasers

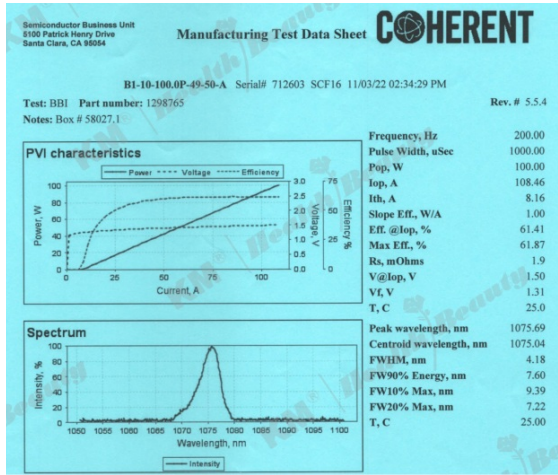

**USA Coherent imported laser bar WITH Certification**

**Magnetic force + fixing pin + curved edge teeth, handle head no light leakage and stronger**



**Screen program supports customization**

**When adjusting the treatment parameters, you can directly input it, which is convenient and quick.**



# Enter parameters directly

Improve work efficiency while quickly setting treatment parameters



1. 4 waves 1064nm +808nm + 755nm+940nm, 4 in 1 all skin type can be used

2.High power: NEW 800W / 1000W/ 1200W / 1600W / 1800W / 2000W / 2400W handle for options

3.Medical handle 4Quattro spot size 15\*25mm/15\*35mm face & body hair removal solution!

4.Cooling system: Unique Sapphire+Semiconductor+ICE+TEC cooling system, most effective to ensure machine work all day, 24hr no down time.



# Water and electricity separation design



PP cotton and resin double filters



Italy brand water pump



Extra TEC cooling



15.6 inch screen with WIFI and Bluetooth



Upgradable smart control board



Big capacitor water tank



Medical Standard power supply

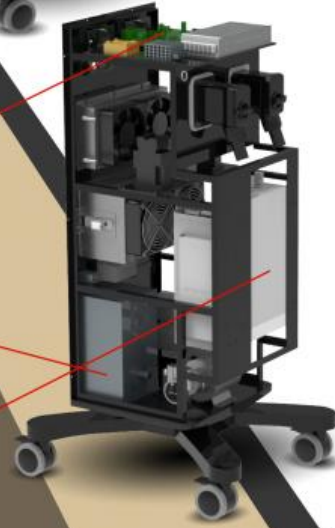
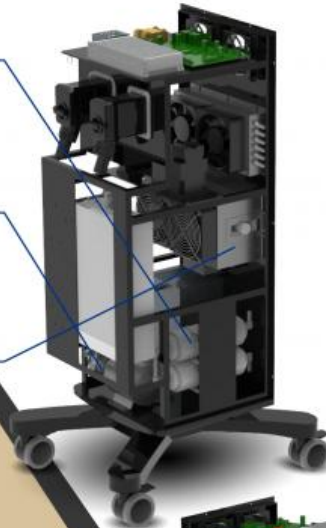

## Laser Handle

The handle can be cooled up to **-15°C**, and the treatment is completely **pain-free**



#### Screen linkage

There is a **small screen behind the small handle** that can be connected to the machine screen, which is very convenient to adjust the parameters

### HANDLE SCREEN

The parameters can be adjusted on the handle control screen  
Convenient and fast operation



2022 Version handpiece with LCD

1) You can adjust treatment parameters directly via handpiece screen even during treatment.

2) Much convenient and intelligent technology with KM quality .

#### WHY CHOOSE US

Professional OEM , ODM service for Ice laser machine

1) **In stock 12 hours delivery**

2) **Print any color** you want for your machine, make it be your and your client's favorite.

3) **Print your logo** on the machine shell and add it to the system as a welcome interface. Make it exclusive in the world.

4) **Add any language** into the machine system, according to you and your client's requirements.

5) Add the Remote Rental System into the machine to do lease business.

6) **Design an exclusive machine shell for you, form your own brand in the market.**

7) Design a new interface and system of machine, making it most convenient for you and your clients.

8) Develop the newest technology to satisfy you and your client's demand. Laser machine hair removal made in US hair removal ice hair removal machine laser diode 3 waves beauty machine



### Product Parameters

Laser type	Diode laser
Laser wavelength	808nm or 3 wave 755&808&1064nm or 4 wave 755&808&940&1064nm
Spot size	12*12 mm <sup>2</sup> , 12*20 mm <sup>2</sup> , 15*27 mm <sup>2</sup> , 12*35 mm <sup>2</sup> (optional )
Pulse width	1-300 ms (adjustable)
Energy	1-320 J/cm <sup>2</sup> (adjustable)
Frequency	1-10 Hz(adjustable)
Language	English, Spanish, Italian, German, French, Turkish or any other language as requested
Skin type	I-VI skin type
Update system	USB / SD update
Rent System	Optional
Display	15inch' color touch LCD display
Laser module power	600W/800W/1000w/1200W/1600W/1800W/2000W/2400W
Cooling	water + air + semiconductor + A/C+TEC big cooler part

## Company Profile

### OUR STRENGTH

WEIFANG KM ELECTRONICS CO.,LT



14+

YEARS EXPERIENCE

AESTHETICS MEDICAL-EQUIPMENT

OEM&ODM

- 📄
**100+**  
Patented technologies
- 📄
**500+**  
OEM real case
- 📄
**45+**  
R & D team
- 📄
**10000+**  
World-class supplier resources

\* TUV medical CE approved 93/42/EEC standard

\* TUV ISO 13485:2016 newest standard and more strict for production line inspection

\* There is few supplier get Medical CE and ISO13485 from TUV in China market now

\* KM was founded in 2009, and we employ more than 100 highly valued team members. Every year, our team participates in beauty machine exhibitions to actively learn about the demands of the beauty market from the customers and other industry professionals themselves. This allows us added knowledge to design more competitive products

\* KM has many medical and production certifications around the world, including (TUV) CE, (TUV) ISO 13485:2016, new type machine shell patent certification, Import and export license, Medical equipment production enterprise license and we have been awarded a High-tech enterprise certificate in China.

\* KM's enterprise vision is customer-oriented and we are dedicated to providing end customers with high quality and cost efficient beauty equipment. KM continues to work hard for customers in order to become a world famous supplier of beauty machines and medical equipment

### INTERNATIONAL SERVICE CENTER

Today's quality, tomorrow's market.



## CUSTOMER VISIT



ALL KINDS OF POWER  
AND WAVELENGTH LASER  
MODULE CAN REACH  
YOUR REQUIREMENTS

## CERTIFICATE



MDSAP



CE LVD



CE EMC



RoHS



TGA

[Support for querying K-codes on the official website](#)

We have **MDSAP AND TUV ISO 13485** .Certified by **27 EU countries, Brazil, New Zealand, Japan, Canada, and the United States**

KM | *Health/Beauty* Weifang KM Electronics Co., Ltd.

☎ 13606464486

✉ sales@wfkmdz.com

🌐 wfkmdz.com

D3-H-0, D3-H-17, D3-H-18, No. 7999, East Health Street, Yongchun Community, Qingchi Street, High-Tech Zone, Weifang, Shandong, China